

## MA 111, Topic 1: Voting Theory

---

Our first topic in this course is called **Voting Theory**. In this chapter we will discuss several different ways to determine who wins an election based on how people vote. We will also discuss several different ideas of fairness for each of these voting methods.

### The Language of Voting

The votes of each election that we discuss will come in the form of *ballots*. It is often convenient to combine many ballots into a *preference schedule* to make it easier to put a lot of information into a small space.

**Definition 1** (Ballot). A **ballot** is a ranked list of all the options (candidates) a person can vote for in an election.

**Example 2.** Suppose Steve is voting in an election for class president. The students running for president are Albert, Brenda, Chris, and Dave. Steve's ballot looks like

Ballot	
1st	Brenda
2nd	Dave
3rd	Chris
4th	Albert

This means that Steve thinks Brenda is the best choice, Dave is the second-best choice, Chris is the third-best choice, and Albert is the worst choice for president.

It is often convenient to combine many ballots into a *preference schedule* to make it easier to put a lot of information into a small space.

**Definition 3** (Preference Schedule). A **preference schedule** is a table which lists the results of many ballots cast for the same election in compact form.

**Example 4.** Each student in Steve's grade votes for class president. The results are summarized in the following preference schedule.

Votes	7	4	2
1st	A	B	C
2nd	B	D	D
3rd	C	C	B
4th	D	A	A

The numbers in the top row represent the number of people that voted in the order of that column. That is, the 7 above means that 7 students ranked the options for class president in the order: Albert, Brenda, Chris, Dave. Also, 4 students ranked the candidates in the order: Brenda, Dave, Chris, Albert. Finally, 2 students ranked the candidates in the order: Chris, Dave, Brenda, Albert.

**Example 5** (Where do we eat?). Four friends are trying to decide where they should eat. They RANK their preferences with the following results:

Ballot	
1st	Burgers
2nd	Pizza
3rd	Mexican

Ballot	
1st	Burgers
2nd	Pizza
3rd	Mexican

Ballot	
1st	Pizza
2nd	Mexican
3rd	Burgers

Ballot	
1st	Mexican
2nd	Pizza
3rd	Burgers

- Given the above preferences, where should they eat?
- Give a reason that supports a *different* restaurant choice than the one you gave above.

Voting Method: Plurality

**Definition 6** (The Plurality Method of Voting). For each ballot, only the first place vote counted. The “candidate” with the most first place votes is the winner. If ballots are combined into a preference schedule then the Plurality method will ignore all non-1st place votes.

We could also determine who gets 2nd place, 3rd place, etc... ranking the candidates based on their 1st-place votes (However, our main focus is usually only determining which candidate wins 1st place.)

**Definition 7.** A candidate in an election is a **Majority Candidate** if they receive over 50% of 1st-place votes.

**Example 8** (Best Bad Movie 1). Stuart Wellington of the *Flophouse* podcast asks two of his friends to rate the best bad movie. The candidates are *Castle Freak* (CF), *Invisible Maniac* (IM) and *Head of the Family* (HF). He and his friends give the following preferences:

Ballot	Ballot	Ballot
1st CF	1st IM	1st HF
2nd IM	2nd CF	2nd CF
3rd HF	3rd HF	3rd IM

- Which movie will win if the *Plurality* method is used?

There is a 3-way tie for first.

- Which movie do you think should win?

**Example 9** (What to eat? Version 1). (From *In Defense of Food* by Michael Pollan) A group of Americans were asked the following:

“Assume you are alone on a desert island for one year and can have water and one other food. Pick the food you think would be best for your health.

The choices are Alfalfa sprouts, Bananas, Corn, Hot Dogs, Milk Chocolate, Peaches, or Spinach.”

% Votes	7	42	12	4	3	5	27
1st Place	A	B	C	H	M	P	S

- Which food wins if the *Plurality* method is used?

Bananas

- Which food do you think would be best for your health?

**Example 10** (What to eat? Version 2). (From *In Defense of Food* by Michael Pollen)

“Assume you are alone on a desert island for one year and can have water and one other food. Pick the food you think would be best for your health. The choices are Alfalfa sprouts, Bananas, Corn, Hot Dogs, Milk Chocolate, Peaches, or Spinach.”

% Votes	7	42	12	4	3	5	27
1st Place	A	B	C	H	M	P	S
2nd Place	S	C	S	C	C	S	P

- If people are told to include 2nd place choices as well, what ONE food do you think should be chosen?
  
- If people are told to include 2nd place choices as well, what TWO foods do you think should be chosen?

**Example 11** (2013 NCAA Football 1). 37 Sports Writers made predictions for the top 4 rankings in 2013 NCAA football. Their predictions for Alabama (AL), Louisville (LV), Ohio State University (OSU), and Oregon (OR) are given below:

Number of Votes	14	10	8	4	1
1st Place	OSU	OR	LV	AL	OR
2nd Place	AL	AL	OR	LV	LV
3rd Place	OR	LV	AL	OR	AL
4th Place	LV	OSU	OSU	OSU	OSU

- Which school wins if the *Plurality* method is used to select the winner? OSU

- Give a reason that supports a *different* team choice than the answer above.

Voting Method: Borda Count

**Definition 12** (Method: Borda Count). Each voter gives a complete ranking of the candidates. If there are  $N$  candidates, then each  $1^{st}$  place vote a candidate receives is worth  $N$  points. Each  $2^{nd}$  place vote a candidate receives is worth  $N - 1$  points. Each  $3^{rd}$  place vote a candidate receives is worth  $N - 2$  points, and so on. Each last place vote is worth 1 point. The candidate with the most number of points wins the election.

We could also determine who gets 2nd place, 3rd place, etc... using the points of each candidate. (Again, our main focus is usually only determining which candidate wins 1st place.)

**Example 13** (2013 NCAA Football 2). 37 Sports Writers made predictions for the top 4 rankings in 2013 NCAA football. Their predictions for Alabama (AL), Louisville (LV), Ohio State University (OSU), and Oregon (OR) are given below:

Number of Votes	14	10	8	4	1
1st Place	OSU	OR	LV	AL	OR
2nd Place	AL	AL	OR	LV	LV
3rd Place	OR	LV	AL	OR	AL
4th Place	LV	OSU	OSU	OSU	OSU

- Which school wins if the *Borda* method is used to select the winner?

$$AL: 14 \times 3 + 10 \times 3 + 8 \times 2 + 4 \times 4 + 1 \times 2 = 106$$

$$LV: 14 \times 1 + 10 \times 2 + 8 \times 4 + 4 \times 3 + 1 \times 3 = 81$$

$$OR: 14 \times 2 + 10 \times 4 + 8 \times 3 + 4 \times 2 + 1 \times 4 = 104$$

$$OSU: 14 \times 4 + 10 \times 1 + 8 \times 1 + 4 \times 1 + 1 \times 1 = 79$$

Alabama Wins!

- Does the *Borda* method always produce the same winner as the *Plurality* method?

No. OSU won with plurality while Alabama won with the Borda count.

**Example 14** (2013 NCAA Football 3). A certain number of Sports Writers made predictions for the top 4 rankings in 2013 NCAA football. Their predictions for Alabama (AL), Louisville (LV), Ohio State University (OSU), and Oregon (OR) are given below:

Number of Votes	?	10	8	4	1
1st Place	OSU	OR	LV	AL	OR
2nd Place	AL	AL	OR	LV	LV
3rd Place	OR	LV	AL	OR	AL
4th Place	LV	OSU	OSU	OSU	OSU

- How many votes are needed for OSU to be the Majority winner?

OSU must have more than half of the votes. There are  $10 + 8 + 4 + 1 = 23$  votes where OSU is not in first. Thus OSU needs at least 24 votes.

- If OSU is the Majority winner, will OSU win using the *Borda* method? If there are 24 votes in the first column we have:

$$AL: 24 \times 3 + 10 \times 3 + 8 \times 2 + 4 \times 4 + 1 \times 2 = 136$$

$$LV: 24 \times 1 + 10 \times 2 + 8 \times 4 + 4 \times 3 + 1 \times 3 = 91$$

$$OR: 24 \times 2 + 10 \times 4 + 8 \times 3 + 4 \times 2 + 1 \times 4 = 124$$

$$OSU: 24 \times 4 + 10 \times 1 + 8 \times 1 + 4 \times 1 + 1 \times 1 = 119$$

No. In this example OSU is the majority winner and finishes in 3<sup>rd</sup> with the Borda count.

**Example 15** (Lexington *One Direction* Fan Club 1). There are four choices for cutest band member (because no one likes Louis): Harry, Liam, Niall, and Zayn. Here's how the 40 person club votes:

Votes	6	4	10	12	8
1st place	H	N	Z	N	L
2nd place	L	H	H	L	H
3rd place	N	L	L	Z	Z
4th place	Z	Z	N	H	N

- Which member will win "Cutest" if the *Plurality* method is used?

Niall wins with 16 votes

- How many points does **Harry** get if the *Borda* method is used?

$$\text{Harry: } 6 \times 4 + 4 \times 3 + 10 \times 3 + 12 \times 1 + 8 \times 3 = 102$$

- How many points does **Niall** get if the *Borda* method is used?

$$\text{Niall: } 6 \times 2 + 4 \times 4 + 10 \times 1 + 12 \times 4 + 8 \times 1 = 94$$

**Example 16** (2012 Best Picture 1). 15 Academy Voters get together to compare their preferences for the 2012 Best Picture. The films under consideration are **Argo**, **Life of Pi**, and **Zero Dark Thirty**. Preference for the voters are summarized below

Votes	6	5	4
1st place	A	Z	L
2nd place	L	L	Z
3rd place	Z	A	A

- Which movie will win best picture if the *Plurality* method is used?  
What about if the *Borda* method is used?

Argo wins if Plurality is used.

$$A: 6 \times 3 + 5 \times 1 + 4 \times 1 = 27$$

$$L: 6 \times 2 + 5 \times 2 + 4 \times 3 = 34$$

$$Z: 6 \times 1 + 5 \times 3 + 4 \times 2 = 29$$

Life of Pi wins if Borda is used.

- If the least favorite movie is removed from consideration, with all ballots reorganized (and preferences moved to fill missing gaps), which movie will win if *Plurality* is used? If *Life of Pi* is removed the preferences become:

votes	6	5	4
1 <sup>st</sup>	A	Z	Z
2 <sup>nd</sup>	Z	A	A

Zero Dark Thirty wins with 9 votes.

### Voting Method: Plurality with Elimination

**Definition 17** (Method: Plurality with Elimination). Each voter casts a ballot for their favorite candidate. If one candidate receives a majority of first-place votes, then that candidate wins the election. If no candidate receives a majority of votes, then the candidate (or candidates) with the **least** number of votes is (are) eliminated, and a new election is held (with votes shifted from before). This continues until a single candidate receives a **majority** of 1st-place votes, and wins the election.

Determining who gets 2nd place, 3rd place, etc. . . is more open using this method. We could make first elimination correspond to last place, 2nd elimination goes with 2nd to last place, etc . . . , but there are other ways as well. (Again, our main focus is usually only determining which candidate wins 1st place.)

**Example 18** (2013 NCAA Football 4). 37 Sports Writers made predictions for the top 4 rankings in 2013 NCAA football. Their predictions for Alabama (AL), Louisville (LV), Ohio State University (OSU), and Oregon (OR) are given below:

Number of Votes	14	10	8	4	1
1st Place	OSU	OR	LV	AL	OR
2nd Place	AL	AL	OR	LV	LV
3rd Place	OR	LV	AL	OR	AL
4th Place	LV	OSU	OSU	OSU	OSU

- Using *Plurality with Elimination*, which team is eliminated first?

Alabama is eliminated first.



- Using *Plurality with Elimination*, which team is eliminated second?

The new schedule without Alabama is:

Votes	14	10	8	4	1	
1st	OSU	OR	LV	LV	OR	Oregon is eliminated.
2nd	OR	LV	OR	OR	LV	
3rd	LV	OSU	OSU	OSU	OSU	

- Which team wins using *Plurality with Elimination*?

The new schedule without Oregon is:

Votes	14	10	8	4	1	
1st	OSU	LV	LV	LV	LV	Louisville wins
2nd	LV	OSU	OSU	OSU	OSU	

**Example 19** (Lexington *One Direction* Fan Club 2). There are four choices for cutest band member (because no one likes Louis): Harry, Liam, Niall, and Zayn. Here's how the 40 person club votes:

Votes	6	4	10	12	8
1st place	H	N	Z	N	L
2nd place	L	H	H	L	H
3rd place	N	L	L	Z	Z
4th place	Z	Z	N	H	N

- Using *Plurality with Elimination*, which member is eliminated first?

Harry

- Second? The new schedule without Harry is

	6	4	10	12	8	
1st	L	N	Z	N	L	Zayn
2nd	N	L	L	L	Z	
3rd	Z	Z	N	Z	N	

- Which member wins using *Plurality with Elimination*?

The new schedule without Zayn is:

	6	4	10	12	8	
1st	L	N	L	N	L	Liam wins
2nd	N	L	N	L	N	

**Example 20** (2012 Best Picture 2). 15 Academy Voters get together to compare their preferences for the 2012 Best Picture. The films under

consideration are **Argo**, **Life of Pi**, and **Zero Dark Thirty**. Preference for the voters are summarized below

Votes	6	5	4
1st place	A	Z	L
2nd place	L	L	Z
3rd place	Z	A	A

- If **A** is no longer a choice, which movie will win if *Plurality* is used?

Without **Argo** the preference schedule becomes:

Votes	6	5	4
1st	L	Z	L
2nd	Z	L	Z

Life of Pi wins with 10 votes.

- If **L** is no longer a choice, which movie will win if *Plurality* is used?

The new preference schedule without **Life of Pi** is:

Votes	6	5	4
1st	A	Z	Z
2nd	Z	A	A

Zero Dark Thirty wins with 9 votes

- If **Z** is no longer a choice, which movie will win if *Plurality* is used?

The preference schedule without **Z** is:

Votes	6	5	4
1st	A	L	L
2nd	L	A	A

Life of Pi wins with 9 votes.

**Example 21** (Lexington *One Direction* Fan Club 3.1). There are four choices for cutest band member (because no one likes Louis): Harry, Liam, Niall, and Zayn. Here's how the 40 person club votes:

Votes	6	4	10	12	8
1st place	H	N	Z	N	L
2nd place	L	H	H	L	H
3rd place	N	L	L	Z	Z
4th place	Z	Z	N	H	N

- If **L** and **Z** are no longer choices, who will win if *Plurality* is used?

If L and Z are not choices we have

Votes	6	4	10	12	8
1st	H	N	H	N	H
2nd	N	H	N	H	N

H wins with 24 votes

- If **N** and **Z** are no longer choices, who will win if *Plurality* is used?

Looking at each column we are comparing H and L. H is preferred  $6+4+10=20$  times. L is preferred  $12+8=20$  times. So H and L tie.

**Example 22** (Lexington *One Direction* Fan Club 3.2). There are four choices for cutest band member (because no one likes Louis): Harry, Liam, Niall, and Zayn. Here's how the 40 person club votes:

Votes	6	4	10	12	8
1st place	H	N	Z	N	L
2nd place	L	H	H	L	H
3rd place	N	L	L	Z	Z
4th place	Z	Z	N	H	N

- If **H** and **L** are no longer choices, who will win if *Plurality* is used?

We are comparing N and Z. N is preferred  $6+4+12=22$  times. Z is preferred  $10+8=18$  times. N wins

- If **H** and **Z** are no longer choices, who will win if *Plurality* is used?

Now we are comparing L and N.  
 L is preferred  $6 + 10 + 8 = 24$  times.  
 N is preferred  $4 + 12 = 16$  times.  
 L wins.

**Example 23** (Lexington *One Direction* Fan Club 3.3). There are four choices for cutest band member (because no one likes Louis): Harry, Liam, Niall, and Zayn. Here's how the 40 person club votes:

Votes	6	4	10	12	8
1st place	H	N	Z	N	L
2nd place	L	H	H	L	H
3rd place	N	L	L	Z	Z
4th place	Z	Z	N	H	N

- If **H** and **N** are no longer choices, who will win if *Plurality* is used?

We are comparing L and Z.  
 L is preferred  $6 + 4 + 12 + 8 = 30$  times.  
 Z is preferred 10 times.  
 L wins.

- If **L** and **N** are no longer choices, who will win if *Plurality* is used?

We are comparing H and Z.  
 H is preferred  $6 + 4 + 8 = 18$  times.  
 Z is preferred  $10 + 12 = 22$  times.  
 Z wins.

Voting Method: Pairwise Comparison

**Definition 24** (Method: Pairwise Comparison). Each voter gives a complete ranking of the candidates. For each pair of candidates, the number of voters preferring each are compared. The candidate receiving more votes (just like in Plurality) receives one point. In case of a tie, each candidate receives one-half point. After all pairs of candidates are compared, the candidate with the most points wins the election.

It will often be very useful to make a **Pairwise Comparison** or **Matchup Chart** when using ideas related to Pairwise Comparison.

We could also determine who gets 2nd place, 3rd place, etc... using the points of each candidate. (Again, our main focus is usually only determining which candidate wins 1st place.)

**Example 25** (2013 NCAA Football 5). 37 Sports Writers made predictions for the top 4 rankings in 2013 NCAA football. Their predictions for Alabama (AL), Louisville (LV), Ohio State University (OSU), and Oregon (OR) are given below:

Number of Votes	14	10	8	4	1
1st Place	OSU	OR	LV	AL	OR
2nd Place	AL	AL	OR	LV	LV
3rd Place	OR	LV	AL	OR	AL
4th Place	LV	OSU	OSU	OSU	OSU

- Which team wins if the *Pairwise Comparison* method is used?

AL vs. LV : AL wins ; AL:  $14+10+4=28$  LV:  $8+1=9$   
 AL vs. OR : OR wins ; AL:  $14+4=18$  OR:  $10+8+1=19$   
 AL vs. OSU : AL wins ; AL:  $10+8+4+1=23$  OSU: 14  
 LV vs. OR : OR wins ; LV:  $8+4=12$  OR:  $14+10+1=25$   
 LV vs. OSU : LV wins ; LV:  $10+8+4+1=23$  OSU: 14  
 OR vs. OSU : OR wins ; OR:  $10+8+4+1=23$  OSU: 14

	AL	LV	OR	OSU
points	2	1	3	0

OR wins

- Is the winner under *Pairwise Comparison* the same as any other previous method? No. OSU won with plurality, Alabama won with Borda count.

**Example 26** (2012 Best Picture 3). 15 Academy Voters get together to compare their preferences for the 2012 Best Picture. The films under consideration are **A**rgo, **L**ife of Pi, and **Z**ero Dark Thirty. Preference for the voters are summarized below:

Votes	6	5	4
1st place	A	Z	L
2nd place	L	L	Z
3rd place	Z	A	A

- What is the MAXIMUM number of points a movie could win if the *Pairwise Comparison Method* is used?

Each movie is compared with two movies. The maximum points a movie could win is two.

- How many TOTAL comparisons are made to determine the winner?

Three comparisons are made (A vs L, A vs Z and L vs Z).

**Example 27** (2013 NCAA Football 6). 37 Sports Writers made predictions for the top 4 rankings in 2013 NCAA football. Their predictions for Alabama (**AL**), Louisville (**LV**), Ohio State University (**OSU**), and Oregon (**OR**) are given below:

Number of Votes	14	10	8	4	1
1st Place	OSU	OR	LV	AL	OR
2nd Place	AL	AL	OR	LV	LV
3rd Place	OR	LV	AL	OR	AL
4th Place	LV	OSU	OSU	OSU	OSU

- What is the MAXIMUM number of points a team could win if the *Pairwise Comparison Method* is used?

Each team is compared with three teams. The maximum number of points a movie could win is three.

- How many TOTAL comparisons are made to determine the winner?

From a previous example we saw that there were six comparisons made.

**Definition 28** (Pairwise Comparison Points). Consider a Pairwise Comparison Election with  $n$  candidates:

- The most points a candidate can win is  $n - 1$  points.  
An election can have at most one candidate that wins  $n - 1$  points under Pairwise Comparison. Such a candidate is called the **Condorcet Candidate**.
- The total number of points awarded during the Pairwise Comparison Election is given by the rule

$$\frac{n(n-1)}{2}$$

For  $n = 3$ , there are  $\frac{3(3-1)}{2} = 3$  Total Points.

For  $n = 4$ , there are  $\frac{4(4-1)}{2} = 6$  Total Points.

For  $n = 5$ , there are  $\frac{5(5-1)}{2} = 10$  Total Points.

**Example 29** (Lexington *One Direction* Fan Club 4). There are five choices for cutest band member: Harry, Liam, Louis, Niall, and Zayn. Suppose we know how the *Pairwise Comparison* points for everyone EXCEPT Zayn.

Name	Harry	Liam	Louis	Niall	Zayn
Points	4	3	1	0	?

- Do we know the winner if the method of *Pairwise Comparison* is used? Yes! Harry won the most points possible with 4 points.

- Do we know how many points Zayn will get?

There are 10 total points and  $4+3+1=8$  have been accounted for. Thus Zayn must have gotten  $10-8=2$  points!

**Example 30** (2013 NCAA Football 7). 37 Sports Writers made predictions for the top 4 rankings in 2013 NCAA football. Suppose we only know how the *Pairwise Comparison* points for their predictions for Alabama and Oregon.

Name	Alabama	Louisville	Ohio State University	Oregon
Points	2.5	?	??	2

- Is it possible for Louisville or Ohio State to win using *Pairwise Comparison*? *No. There are six points total - For Louisville or Ohio State to tie with Alabama they would need 2.5 points. This would mean  $2.5 + 2.5 + 2 = 7$  points awarded which can't happen.*
- How many combined points are shared between Louisville and Ohio State?  *$6 - (2.5 + 2) = 6 - 4.5 = 1.5$  points*

Voting Method: Bracket Voting

**Definition 31** (Method: Bracket Voting). Each voter gives a complete ranking of the candidates.

- Using the voter rankings, make a Matchup Chart (as you would if you were using the Pairwise Comparison method).
- A predetermined candidate (you are always told which one) is chosen to be the winner. *Cross Out* all matchups where that candidate loses. If the candidate loses **ALL** matchups then the candidate cannot win under Bracket Voting.
- Start by arranging the candidates in a "Bracket" so that the chosen candidate beats another candidate. Then use the comparisons to find a third candidate that either of the first two candidates can beat. Repeat this process until all candidates appear in the bracket. The "shape" of the bracket may vary with examples and choices made.

**Example 32** (NCAA Basketball 1). 6 coaches give informally rankings to 4 college basketball teams. Their predictions for Indiana (**I**), Louisville (**L**), Ohio State University (**O**), and Kentucky (**K**) are given below:



Number of Votes	2	1	2	1
1st place	K	L	I	O
2nd place	L	O	K	L
3rd place	O	I	O	I
4th place	I	K	L	K

- Which team(s) will **Kentucky** beat if the *Pairwise Comparison* method is used?

Louisville and OSU.

- Which team(s) will **Kentucky** lose to if the *Pairwise Comparison* method is used?

Indiana

- Use the voting information for the previous question to fill in a bracket where **Kentucky** is the winner of the bracket.

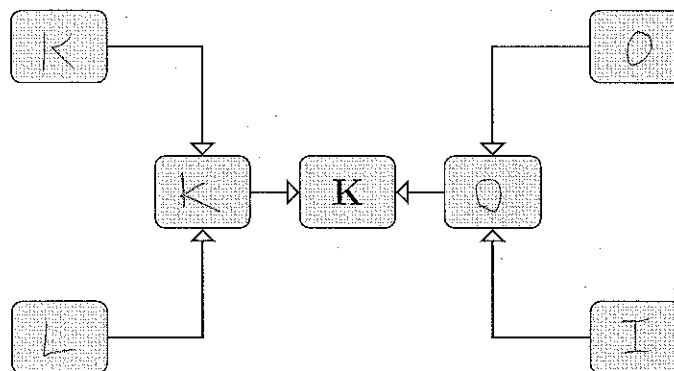

**Example 33** (New *One Direction* Fan Club 1). The Lexington *One Direction* fan club adds two members (now a total of 42). Again, no one likes Louis so the the four choices for cutest band member are: Harry, Liam, Niall, and Zayn. Here's how the 42 person club votes:

<b>Votes</b>	8	4	10	12	8
1st place	H	N	Z	N	L
2nd place	L	H	H	L	H
3rd place	N	L	L	Z	Z
4th place	Z	Z	N	H	N

- Who does **Zayn** beat under the *Pairwise Comparison* method?

Harry

- Who does Zayn lose to under the *Pairwise Comparison* method?

Niall and Liam.

**Example 34** (New *One Direction* Fan Club 2). The Lexington *One Direction* fan club adds two members (now a total of 42). Again, no one likes Louis so the the four choices for cutest band member are: Harry, Liam, Niall, and Zayn. Here's how the 42 person club votes:

Votes	8	4	10	12	8
1st place	H	N	Z	N	L
2nd place	L	H	H	L	H
3rd place	N	L	L	Z	Z
4th place	Z	Z	N	H	N

- Who can Zayn beat using the *Pairwise Comparison* method? Who can that person beat?

Zayn can beat Harry. Harry can beat Liam and Niall.

- Design a bracket (with a new shape) where Zayn will win.

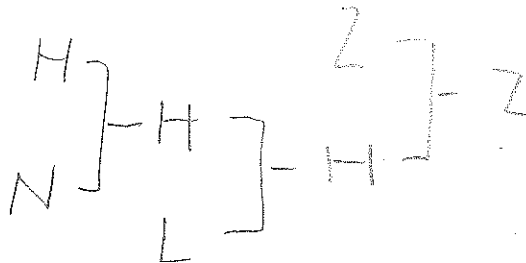

**Example 35** (New *One Direction* Fan Club 3). The Lexington *One Direction* fan club adds two members (now a total of 42). Again, no one likes Louis so the the four choices for cutest band member are: Harry, Liam, Niall, and Zayn. Here's how the 42 person club votes:

Votes	8	4	10	12	8
1st place	H	N	Z	N	L
2nd place	L	H	H	L	H
3rd place	N	L	L	Z	Z
4th place	Z	Z	N	H	N

- Who can Niall beat using the *Pairwise Comparison* method? Who can that person beat?

Niall can beat Zayn. Zayn can beat Harry.

- Design a bracket that will make guarantee Niall will win.

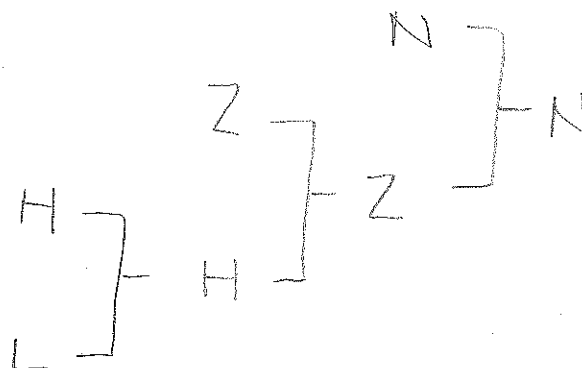

**Example 36** (Best Bad Movie 2). Stuart Wellington of the *Flophouse* podcast asks listeners to vote on their favorite bad movie. The candidates are *Castle Freak* (**CF**), *Invisible Maniac* (**IM**) and *Head of the Family* (**HF**). Listeners give the following preferences:

Votes	10	12	15	4
1st place	CF	IM	HF	IM
2nd place	HF	HF	CF	CF
3rd place	IM	CF	IM	HF

- Design a bracket so that *Head of the Family* (**HF**) wins?

CF vs. HF : HF  
 CF vs. IM : CF  
 HF vs. IM : HF

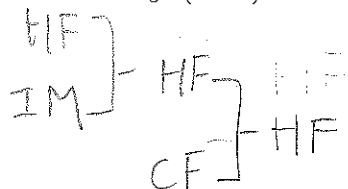

(last column)

- What way can you increase the blue votes so that *Invisible Maniac* (IM) wins under ANY bracket?

Increase the number of votes so that IM has a majority. Then IM will win under any bracket.

### 2-Candidate Voting

The next definitions and examples involve elections that have only two candidates. We will use this to introduce our ideas of fairness in voting.

**Definition 37** (2-Candidate Voting Method: Majority Rule). **Majority Rule** is a form of 2-candidate voting in which the candidate who receives the most votes is the winner of the election.

**Example 38.** The ballots for an election are given below,

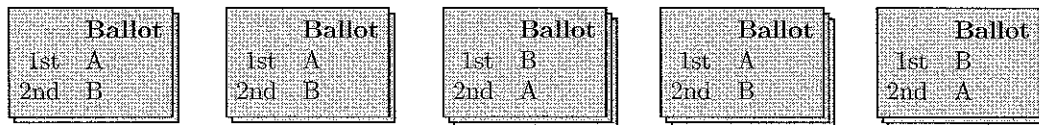

if the election is to be decided by Majority Rule then Candidate A is the winner. In a 2-candidate election, unless both candidates tie, one candidate will always have a majority.

All of the methods we have learned so far (Plurality, Borda, Plurality with Elimination, Pairwise Comparison) become Majority Rule when applied to 2-Candidate elections.

**Definition 39** (2-Candidate Voting Method: Minority Rule). **Minority Rule** is a form of 2-candidate voting in which the candidate who receives the least votes is the winner of the election.

**Example 40.** The ballots for an election are given below,

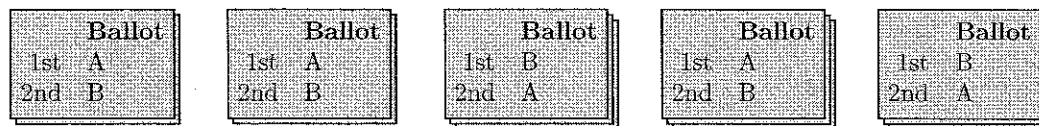

if the election is to be decided by Minority Rule then Candidate B is the winner.

**Definition 41** (2-Candidate Voting Method: Dictatorship). A

**Dictatorship** is a form of voting in which one person (the dictator) has absolute authority. Their vote is the only one that counts. The winner of the election is determined by the dictator's vote.

**Example 42.** The ballots for an election are given below and

Ballot	Ballot	Ballot	Ballot	Ballot
1st A 2nd B	1st A 2nd B	1st B 2nd A	1st A 2nd B	1st B 2nd A

Dictator ↑

then Candidate B will win under a dictatorship.

Although it is defined here for 2-candidate elections, Dictatorship is a possible method any kind of election.

**Definition 43** (2-Candidate Voting Method: Imposed Rule). **Imposed Rule** is a form of voting in which the election is predetermined *before the ballots are cast*. The election is not determined by how people vote because nobody's vote matters.

**Example 44.** The ballots for an election are given below,

Ballot	Ballot	Ballot	Ballot	Ballot
1st A 2nd B	1st A 2nd B	1st B 2nd A	1st A 2nd B	1st B 2nd A

but the current *Imposed Rule* government decides that Candidate C is the winner. Then Candidate C is the winner.

The example given is meant to convey how the actual ballots are disregarded. In most uses of Imposed Rule, the winning candidate actually appears on the ballot.

**Example 45** (2-Candidate Elections 1). Five employees of a restaurant vote on which of their managers (designated as **A** and **B**) should be promoted to a new position in Fairbanks, AK. They cast the following ballots:

Ballot	Ballot	Ballot	Ballot	Ballot
1st A 2nd B	1st A 2nd B	1st B 2nd A	1st A 2nd B	1st B 2nd A

- If *Majority Rule* is used, which manager wins the promotion?

Manager A

- If Employee #3 (whose ballot is in the center) is the Dictator and the winner is determined using *Dictatorship*, which manager will win the promotion?

Manager B

**Example 46** (2-Candidate Elections 2). Five employees of a restaurant vote on which of their managers (designated as **A** and **B**) should be promoted to a new position in Fairbanks, AK. They cast the following ballots:

Ballot	Ballot	Ballot	Ballot	Ballot
1st A 2nd B	1st A 2nd B	1st B 2nd A	1st A 2nd B	1st B 2nd A

- If *Minority Rule* is used, which manager wins the promotion?

Manager B

- What are the possible outcomes if the method of *Imposed Rule* is used?

Any outcome is possible.

**Example 47** (2-Candidate Elections 3). Five employees of a restaurant vote on which of their managers (designated as **A** and **B**) should be promoted to a new position in Fairbanks, AK. They cast the following ballots:

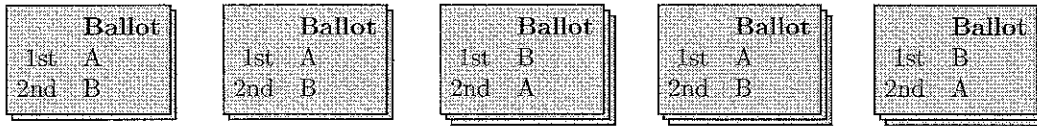

- If everyone reverses how they vote (1st place goes to 2nd, 2nd place goes to 1st), which manager will win if *Majority Rule* is used? Is this different than before?

Manager B. Before manager A won.

- Do you think a reversal (as above) of how people vote should change the outcome of an election? Why or why not?

**Example 48** (2-Candidate Elections 4). Five employees of a restaurant vote on which of their managers (designated as **A** and **B**) should be promoted to a new position in Fairbanks, AK. They cast the following ballots:

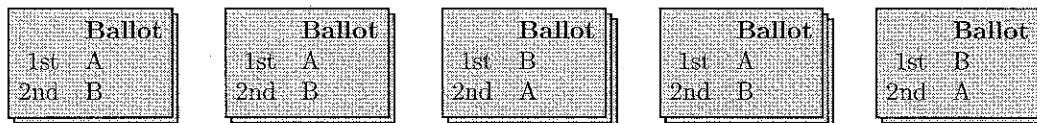

- If Voter 1 (leftmost ballot) decides to put Candidate **B** in 1st place instead (with Candidate **A** in 2nd place), who will win the election if *Minority Rule* is used?

Manager A

- The process above effectively gives Candidate **B** more votes. Should receiving more votes hurt a Candidate's chance of winning? Why or why not?

**Example 49** (2-Candidate Elections 5). Five employees of a restaurant vote on which of their managers (designated as **A** and **B**) should be promoted to a new position in Fairbanks, AK. They cast the following ballots:

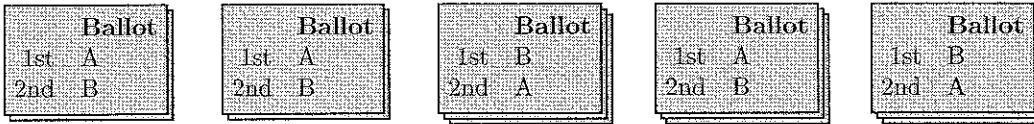

- If Voter 1 (leftmost ballot) and Voter 3 (center ballot) decide to swap ballots, which manager will win if *Majority Rule* is used? What if *Minority Rule* is used? *Manager A wins under Majority Rule. Manager B wins under Minority Rule.*
- Do you think two voters agreeing to swap their ballots as above should change the outcome of an election? Why or why not?

### 2-Candidate Fairness

Now we want to discuss what it means for a voting method to be fair. The following definitions should all make sense if you understand the reasoning behind the definition. Try to focus on where these definitions come from, not necessarily just memorizing them.

**Definition 50** (2-Candidate Fairness Idea: Anonymous). A voting system is **anonymous** if it treats all of the voters equally. If any two voters traded ballots, the outcome of the election would remain the same.

**Example 51.** So for example, if the ballots below

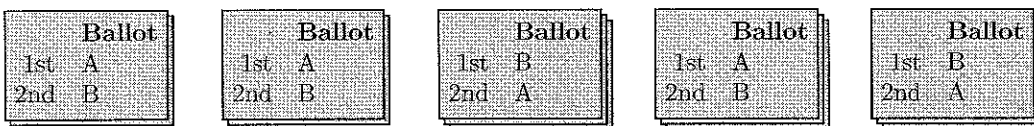

became the following (ballots 2 and 3 swap position)

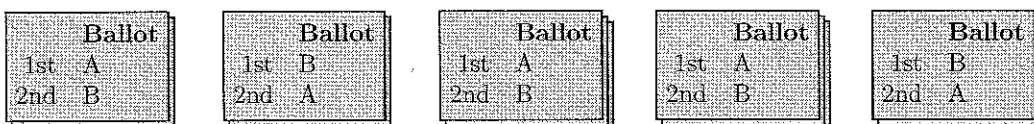



the winner of the election will stay the same *if the voting system is anonymous.*

**Definition 52** (2-Candidate Fairness Idea: Monotone). A voting system is **monotone** if it is impossible for a winning candidate to become a losing candidate by gaining votes or for a losing candidate to become a winning candidate by losing votes.

**Example 53.** So for example, if the ballots below

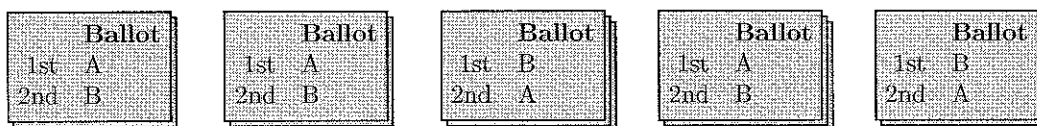

became the following (ballot 3 changes)

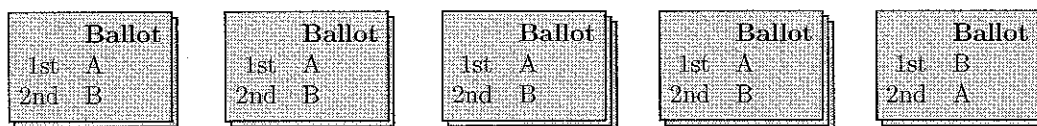

the winner of the election will stay the same *if the voting system is monotone.*

**Definition 54** (2-Candidate Fairness Idea: Neutral). A voting system is **neutral** if it treats candidates equally. This means if every voter switched their vote to the other candidate, the outcome of the election switches too.

**Example 55.** So for example, if the ballots below

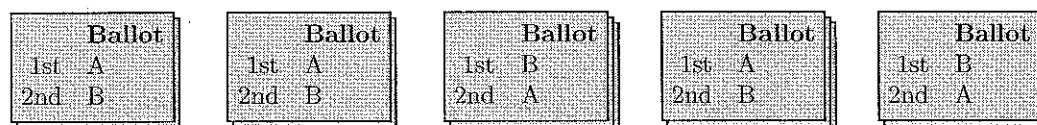

were switched (everyone swaps their vote around)

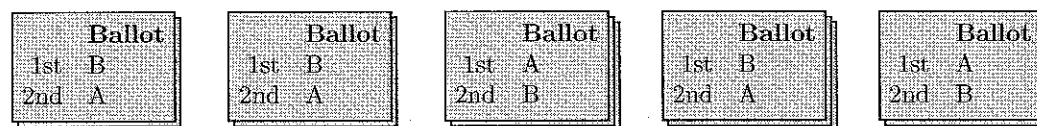

the winner of the election will also switch *if the voting system is neutral.*

**Theorem** (May's Theorem). In a two-candidate election **Majority Rule** is the only voting system that is anonymous, neutral, and monotone. If there are an odd number of voters, **Majority Rule** will also avoid all possibility of ties.

A **theorem** is a (mathematical) idea that is true in all cases whenever certain conditions are met. It is (usually) easy to show a certain idea *DOESN'T* work by just finding an example that meets the conditions but without the conclusion we want.

Proving a theorem, which means establishing a general principle, is much harder to do.

May's Theorem conclusively establishes what may feel obvious: **Majority Rule** is the best form of 2-candidate voting.

### Adjusting Elections to Get Certain Results

**Example 56** (Gus Chewed Some Ballots 3). Some graduate students in sociology want to look at some historical data. Unfortunately, Gus the dog chewed up the summary of an election from a long time ago! (The actual ballots have been lost to time.) In the election below, it is known that **13 total votes were cast!** The two unknown votes could be anything!

Number of Votes	7	3	1
1st Place	A	B	C
2nd Place	B	C	A
3rd Place	C	A	B

- Where should the extra votes go if Candidate **A** is going to win using the *Borda* method?

The extra votes should go to the first column.

- Could the extra votes go anywhere to make Candidate **B** win using the *Borda* method?

If we add 2 votes to the second column we have 28 pts for A, 30 pts for B and 20 pts for C. So B would win under Borda count.

### Voting Fairness Idea: Majority Criterion

**Definition 57** (Voting Fairness Idea: Majority Criterion (MJ)). A voting system satisfies the **Majority Criterion** if a candidate with over 50% of first-place votes automatically wins the election.

In the ballots below,

Ballot	
1st	A
2nd	C
3rd	B

Ballot	
1st	A
2nd	C
3rd	B

Ballot	
1st	C
2nd	B
3rd	A

Ballot	
1st	A
2nd	C
3rd	B

Ballot	
1st	C
2nd	B
3rd	A

Candidate A will automatically win the election if the voting system satisfies the **Majority Criterion**.

This idea of fairness in voting usually feels “the most fair”. This may have more to do with how we have been conditioned to think about voting.

**Example 58** (Gus Chewed Some Ballots 1). On election day, 11 voters cast their votes. Unfortunately Gus, the dog kept at the local polling station, got into the ballots and ate some of the results. Only the following information is known:

Number of Votes	8	2	1
1st Place	A	B	C
2nd Place	?	?	?
3rd Place	?	?	?

- Which candidate will win if the *Plurality* Method is used? How do you know for sure?

A would win under plurality. Only first place votes count so we have all the information we need to find the winner.

- How many absentee ballots (not included in the 11 above) could there be to guarantee your answer above is correct?

We could add 5 ballots to make B have at best 7 first place votes.

**Example 59** (Gus Chewed Some Ballots 4). Gus regurgitates the chewed summary. GROSS! The sociology graduate students are able to examine all of the votes of the historical election. The summary shows the following:

Number of Votes	7	5	1
1st Place	A	B	C
2nd Place	B	C	A
3rd Place	C	A	B

- Describe the nature of Candidate A's victory if the *Plurality* method is used?

Candidate A is a majority candidate.

- Who wins if the *Borda* method is used? What does the example tell you about the *Borda* method and fairness?

We've seen before in Example 56 that B wins. This shows that the Borda method violates the majority criterion since the majority candidate A loses under Borda count.

**Example 60** (Best Bad Movie 3). Stuart Wellington of the *Flophouse* podcast asks listeners to vote on their favorite bad movie. The candidates are *Castle Freak* (**CF**), *Invisible Maniac* (**IM**) and *Head of the Family* (**HF**). Listeners give the following preferences:

Votes	17	18	12	?
1st place	<b>CF</b>	<b>HF</b>	<b>HF</b>	<b>IM</b>
2nd place	<b>HF</b>	<b>IM</b>	<b>CF</b>	<b>CF</b>
3rd place	<b>IM</b>	<b>CF</b>	<b>IM</b>	<b>HF</b>

- Find a number for the blue votes that will guarantee **IM** wins in the first round using the *Plurality with Elimination* method.

If IM has the majority of first place votes it will win in the first round.

One number that works is 48.

- An election has 4 candidates (A, B, C, D) and candidate A wins the majority. Can you say for certain who will win if *Plurality with Elimination* is used?

Yes, candidate A will win.

Voting Fairness Idea: Monotonicity Criterion

**Definition 61** (Voting Fairness Idea: Monotonicity Criterion (MO)). A voting system satisfies the **Monotonicity Criterion** if an improvement in a given candidate's vote, without changing the relative quality of the other candidate's votes, does not hurt the given candidate's chance of winning the election.

Like what we saw with 2-Candidate elections, if the ballots below

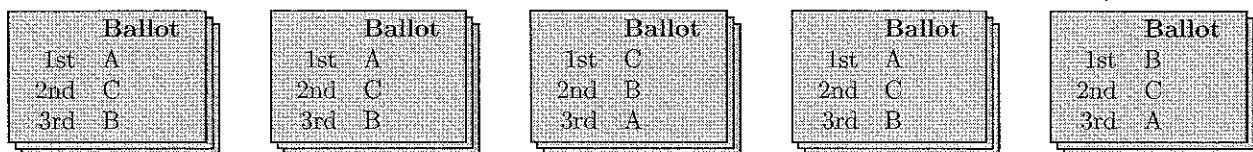

became the following

(a change in Ballot #5 ↓)

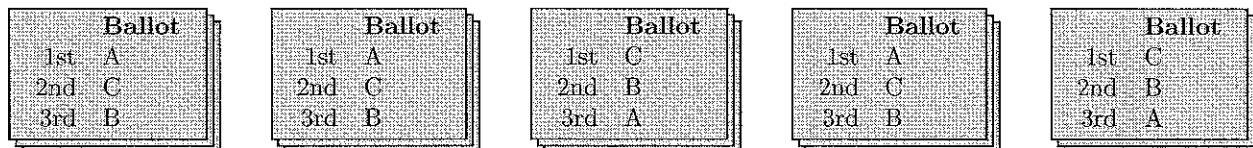

this should *NOT HURT* Candidate C (because there are now more favorable 1st-place votes). This happens when a voting system satisfies the **Monotonicity Criterion**.

**Example 62** (Gus Chewed Some Ballots 2). During the next election day, 15 voters cast their votes. And again Gus gets into the ballots! This time the chewed ballots look like the following:

Number of Votes	4	5	1
1st Place	A	B	C
2nd Place	?	?	?
3rd Place	?	?	?

- Five absentee ballots were not chewed. Before looking at the ballots, which candidates could win if the *Plurality* method is used?

Any of the candidates could win.

- From the chewed ballot information, it appears that Candidate **B** will win the election. If all absentee ballots support Candidate **B**, is there a chance that Candidate **B** could lose under *Plurality*?

No. B would have 10 first place votes and A would have 4 and C would have 1.

**Example 63** (Orange is the New Black 1). Piper must determine a new snack to be offered in the prison vending machine. She consults fellow prisoners and finds that **C**hips, **F**ruit, **N**uts, and **P**retzels are the top choices. The prisoners give the following preferences:

Votes	7	8	10	2	2
1st place	C	N	P	C	C
2nd place	N	P	F	P	F
3rd place	F	C	C	F	N
4th place	P	F	N	N	P

- Which snack should be eliminated in the first round of *Plurality with Elimination*?

Fruits

- Which snack will win if *Plurality with Elimination* is used?

Nuts would be eliminated second and Pretzels would win.

**Example 64** (Orange is the New Black 2). A prison riot destroys the vote results before they can be certified. Again the prisoners are asked to vote on **C**hips, **F**ruit, **N**uts, and **P**retzels are the top choices. Some people remember which snack won previously, and change their vote to be on the winning side:

Votes	7	8	10	2	2
1st place	C	N	P	P	P
2nd place	N	P	F	C	C
3rd place	F	C	C	F	F
4th place	P	F	N	N	N

- Which snack will win if *Plurality with Elimination* is used?

Fruits would be eliminated, then chips. This would give nuts the win.

- Does the same snack win as in *Plurality with Elimination* election?

No.

- How does this election differ from the previous election?

Pretzels gained support but lost the election. This shows that *Plurality with Elimination* violates the *Monotonicity Criterion*.

Voting Fairness Idea: Condorcet Criterion

**Definition 65** (Voting Fairness Idea: Condorcet Criterion (CO)). A candidate who wins all possible points if *Pairwise Comparison* were used (even if another method is actually being used) is called a **Condorcet Candidate** (or **Condorcet Winner**). A voting system satisfies the **Condorcet Criterion** if the *Condorcet Candidate* always wins.

In the ballots below,

Ballot	
1st	A
2nd	C
3rd	B

Ballot	
1st	A
2nd	C
3rd	B

Ballot	
1st	C
2nd	B
3rd	A

Ballot	
1st	A
2nd	C
3rd	B

Ballot	
1st	C
2nd	B
3rd	A

we get the following comparisons:

Matchup	Points	Matchup	Points	Matchup	Points
A vs. B	1 for A	A vs. C	1 for A	B vs. C	1 for C

Candidate A is the **Condorcet Candidate** with 2 points, the most possible in a 3-candidate election. To satisfy the **Condorcet Criterion**, a voting system must have Candidate A as the winner.

**Example 66** (Best Bad Movie 4). Stuart Wellington of the *Flophouse* podcast asks listeners to vote on their favorite bad movie. The candidates are *Castle Freak* (CF), *Invisible Maniac* (IM) and *Head of the Family* (HF). Listeners give the following preferences:

Votes	17	18	12	?
1st place	CF	HF	HF	IM
2nd place	HF	IM	CF	CF
3rd place	IM	CF	IM	HF

- Find a number for the blue votes that will guarantee IM wins using the *Pairwise Comparison* method.

One number that works 48. In that case IM has a majority. This means IM would get the most possible pairwise points so IM wins

- How many points will a majority candidate earn in a *Pairwise Comparison* election with 4 candidates? What about 5 candidates?

A majority candidate would have 3 points in a 4 candidate election. For a 5 candidate election the majority candidate would get 4 pts

**Example 67** (2012 Best Picture 3). 15 Academy Voters get together to compare their preferences for the 2012 Best Picture. The films under consideration are *Argo*, *Life of Pi*, and *Zero Dark Thirty*. Preference for the voters are summarized below



Votes	6	5	4
1st place	A	Z	L
2nd place	L	L	Z
3rd place	Z	A	A

- Which film wins if the *Plurality* method is used?

Argo

**Example 68** (2012 Best Picture 4). 15 Academy Voters get together to compare their preferences for the 2012 Best Picture. The films under consideration are *Argo*, *Life of Pi*, and *Zero Dark Thirty*. Preference for the voters are summarized below

Votes	6	5	4
1st place	A	Z	L
2nd place	L	L	Z
3rd place	Z	A	A

- Which film is eliminated in the first round of the *Plurality with Elimination* method?

L, Z wins under plurality with elimination

- How many points does the winning film receive if the *Pairwise Comparison* method is used?

Z receives 1 pt

A vs Z: Z  
L vs Z: L

**Example 69** (2013 NCAA Football 8). 37 Sports Writers made predictions for the top 4 rankings in 2013 NCAA football. Their predictions for Alabama (AL), Louisville (LV), Ohio State University (OSU), and Oregon (OR) are given below:

Number of Votes	14	10	8	4	1
1st Place	OSU	OR	LV	AL	OR
2nd Place	AL	AL	OR	LV	LV
3rd Place	OR	LV	AL	OR	AL
4th Place	LV	OSU	OSU	OSU	OSU

- Do you remember which team wins if the **Borda** method is used?

Alabama

- Do you remember which team wins if the **Pairwise Comparison** method is used? How many points did that team get?

Oregon with 3 points

#### Voting Fairness Idea: CO-MJ Connection

If a candidate gets more than half of all 1st-place votes, then that candidate beats every other candidate with over half the vote. Therefore, this majority candidate will win all head-to-head matchups against every other candidate.

In other words, the **Majority Candidate is ALWAYS the Condorcet Candidate!**

If the voting system satisfies the **Condorcet Criterion**, then the Majority candidate has to be the winner. This says that the candidate who has more than 50% of 1st-place votes is the winner. In other words:

**Theorem (CO-MJ Connection).** Any voting system where the **Condorcet Criterion (CO)** holds is a voting system where the **Majority Criterion (MJ)** holds as well.

Turning the logic around, if the **Majority Criterion (MJ)** DOES NOT hold in a voting system, then the **Condorcet Criterion (CO)** DOES NOT hold as well.

#### Voting Fairness Idea: Indep. of Irr. Alternatives (IIA)

**Definition 70** (Voting Fairness Idea: Ind. of Irrel. Alternatives Criterion (IIA)). If any candidate wins a first election, and one of the irrelevant losing candidates drops out before the second election, then the previous winner should also win the second election.

In the ballots below,

Ballot	
1st	A
2nd	C
3rd	B

Ballot	
1st	A
2nd	C
3rd	B

Ballot	
1st	C
2nd	B
3rd	A

Ballot	
1st	A
2nd	C
3rd	B

Ballot	
1st	C
2nd	B
3rd	A

suppose there is a voting system in which Candidates A and C are in contention to win the election, but Candidate B does not have a chance at winning. A voting system satisfies the **Independence of Irrelevant Alternatives Criterion (IIA)** only if the outcome of the election does not change from absence of Candidate B.

Ralph Nader and Ross Perot are real-world examples of “irrelevant alternatives” or “spoiler” candidates in U.S. presidential elections.

**Example 71** (Another New *One Direction* Fan Club 1). The Lexington *One Direction* fan club adds two members (now a total of 42). Again, no one likes Louis so the the four choices for cutest band member are: Harry, Liam, Niall, and Zayn. Here’s how the 42 person club votes:

Votes	8	4	8	12	10
1st place	H	N	Z	N	L
2nd place	L	H	H	L	H
3rd place	N	L	L	Z	Z
4th place	Z	Z	N	H	N

- Which candidate wins if the *Plurality* method is used? Which candidate(s) is/are most irrelevant if the *Plurality* method is used?

Why? Niall with 16 votes. Zayn and Harry with 8 votes

- Does the outcome of the election change if one (or more) of the irrelevant candidates drop out?

Yes. For instance if Harry drops out Liam wins

**Example 72** (2013 NCAA Football 9). The predictions of 37 Sports Writers (given below) for Alabama (AL), Louisville (LV), Ohio State University (OSU), and Oregon (OR) make Alabama (AL) the Borda winner.

Number of Votes	14	10	8	4	1
1st Place	OSU	OR	LV	AL	OR
2nd Place	AL	AL	OR	LV	LV
3rd Place	OR	LV	AL	OR	AL
4th Place	LV	OSU	OSU	OSU	OSU

- Ohio State (OSU) is not even close to winning if the *Borda* method is used. Which team wins using the *Borda* method if OSU is completely dropped from consideration?

IF OSU is not an option we have:

	14	10	8	4	1	
1st	AL	OR	LV	AL	OR	AL: $14 \times 3 + 10 \times 2 + 8 \times 1 + 4 \times 3 + 1 \times 1 = 83$
2nd	OR	AL	OR	LV	LV	OR: $14 \times 2 + 10 \times 3 + 8 \times 2 + 4 \times 1 + 1 \times 3 = 81$
3rd	LV	LV	AL	OR	AL	LV: $14 \times 1 + 10 \times 1 + 8 \times 3 + 4 \times 2 + 1 \times 2 = 58$
						AL wins

- Louisville (LV) is not even close to winning if the *Borda* method is used. Which team wins using the *Borda* method if LV is completely dropped from consideration?

IF LV is dropped we have:

	14	10	8	4	1	
1st	OSU	OR	OR	AL	OR	AL: $14 \times 2 + 10 \times 2 + 8 \times 2 + 4 \times 3 + 1 \times 2 = 78$
2nd	AL	AL	AL	OR	AL	OR: $14 \times 1 + 10 \times 3 + 8 \times 3 + 4 \times 2 + 1 \times 3 = 79$
3rd	OR	OSU	OSU	OSU	OSU	OSU: $14 \times 3 + 10 \times 1 + 8 \times 1 + 4 \times 1 + 1 \times 1 = 65$
						OR wins

**Example 73** (School Board Election 1). Four candidates A, B, C, and D are running for a seat for the School Board Executive Committee. The School Board voters give the following preferences:

Number of votes	7	7	8	5
1st place	A	<del>C</del>	D	B
2nd place	<del>B</del>	B	<del>C</del>	A
3rd place	<del>C</del>	A	B	<del>C</del>
4th place	D	D	A	D

- Is Candidate B irrelevant under the *Plurality with Elimination* method? What about Candidate C?

Yes, B is the first eliminated.  
Candidate C is irrelevant because they are eliminated second.

- Who wins if the *Plurality with Elimination* is used?

A wins.

- Who will win if Candidate C drops out of the election?

	7	7	8	5	
1 <sup>st</sup>	A	B	D	B	Eliminate A: B wins.
2 <sup>nd</sup>	B	A	B	A	
3 <sup>rd</sup>	D	D	A	D	

**Example 74** (School Board Election 2). A different School Board has four candidates A, B, C, and D running for a seat for the School Board Executive Committee. The School Board voters give the following preferences:

Number of votes	10	7	5	7	4
1st place	A	D	B	C	B
2nd place	C	B	C	D	C
3rd place	B	A	A	A	D
4th place	D	C	D	B	A

- Who wins the election if the *Pairwise Comparison* method is used?

A vs. B: A      B vs. C: C      C vs. D: C      A & C tie  
 A vs. C: A      B vs. D: B  
 A vs. D: D

Pairwise pts	A	B	C	D
	2	1	2	1

- If Candidate **D** drops out, will the winner of the election change in any way?

Yes, the pairwise point totals become:

	A	B	C
pairwise pts	2	0	1

A wins

**Example 75** (School Board Election 3). Below is a summary of the previous School Board Election 2 election. The winner of Head-to-Head Comparisons are given:

Comp.	Winner	Comp.	Winner	Comp.	Winner
A vs B	A	B vs C	C	C vs D	C
A vs C	A	B vs D	B		
A vs D	D				

- Can you make a bracket where Candidate **B** is the winner?

Yes

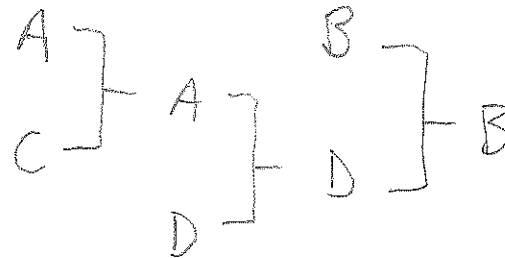

- If Candidate **D** drops out, can you make a bracket where Candidate **B** is the winner?

No, because B loses to both A and C

#### Fairness Idea: Arrow's Theorem

**Theorem** (Arrow's Impossibility Theorem). In an election with more than two candidates, there is NO FAIR method of voting that will simultaneously satisfy the Majority criterion, the Condorcet criterion, the monotonicity criterion, and the Independence of Irrelevant Alternatives criterion.

Here is a summary of how each of the Voting Methods fails the Fairness Criteria:

	MO	MJ	CO	IIA
Plurality	✓	✓	X	X
Borda	✓	X	X	X
Plurality w/ Elimination	X	✓	X	X
Pairwise Comparison	✓	✓	✓	X
Bracket	✓	✓	✓	X

(✓ means "always satisfied" while "X" can fail to satisfy)